

DATA-INFO
56.632

Dataflex®
is a registered
trademark of
DATAFLEX
INTERNATIONAL BV
P.O. Box 713
NL-2920 CA
Krimpen a/d IJssel

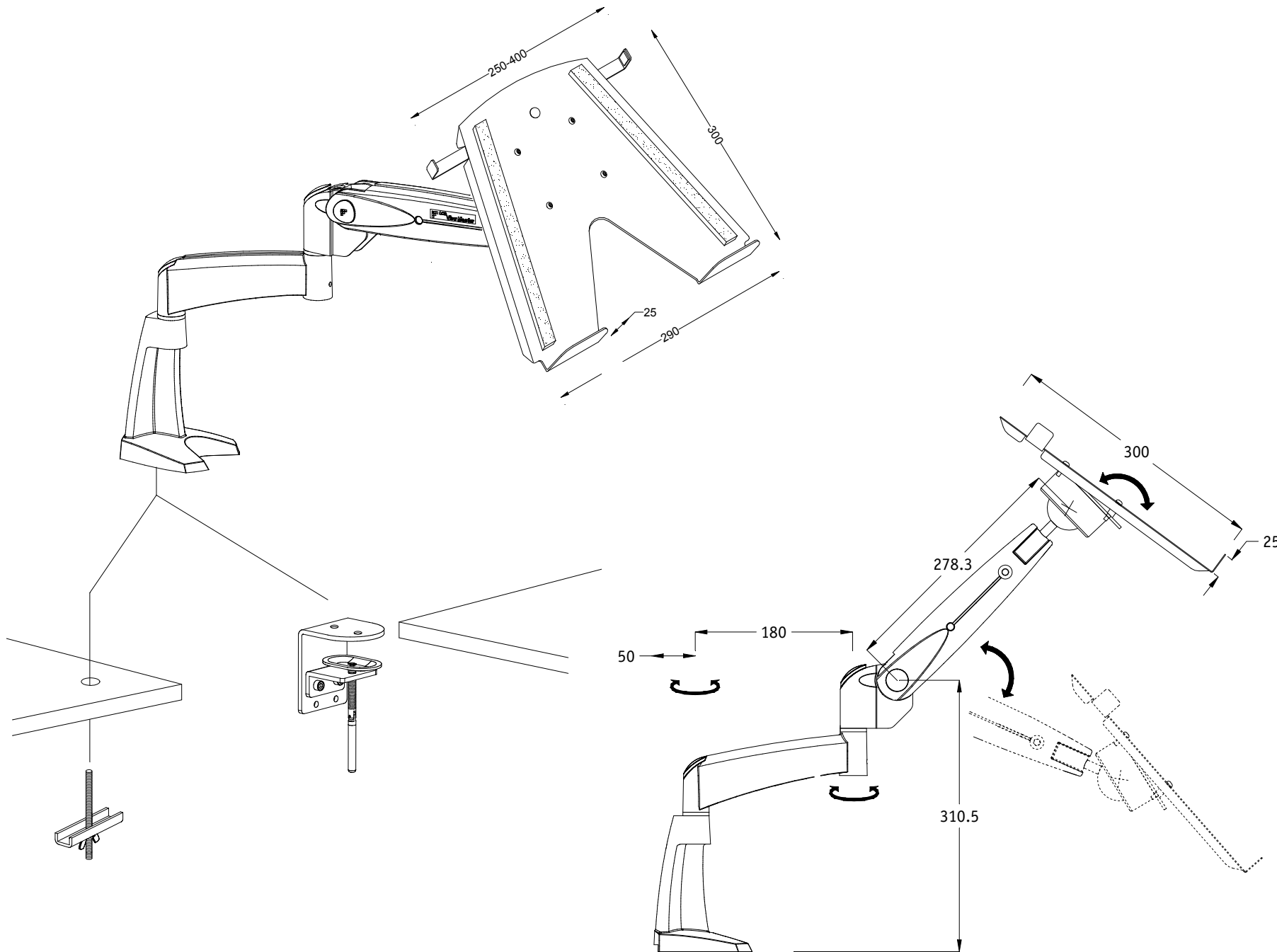

All dimensions in mm - Dimensions en mm - Abmessungen in mm - Alle afmetingen in mm